

Svensk designtidning

Nr 2, vecka 3 - 4/2025

Kungjorda beslut avseende nya mönsterregistreringar, vecka 3 - 4

2025-01-13 - 2025-01-26



Utfärdad av Patent- och registreringsverket Design- och varumärkesavdelningen

Box 530

826 27 SÖDERHAMN

Tel: 08-782 28 00

www.prv.se

kundsupport@prv.se

INNEHÅLLSFÖRTECKNING

Önskar du information om beslut kan du söka i Svensk Designdatabas

Nationella kungörelser

01 - Designregistreringar	1
06 - Förnyelser	26
07 - Ändringar i designregistret	27
09 - Avförda registreringar	28

01 - Designregistreringar

Registreringsnummer 85558 - 85567

Den som vill invända mot en registrering ska göra det inom två månader från kungörelsedagen (samma dag som registreringsdagen).

Invändningen skall innehålla:

Invändarens namn eller firma samt postadress.

Om invändaren är företrädd av ombud, ombudets namn och postadress.

Uppgift om de omständigheter som åberopas till grund för invändningen.

Invändningen ska vara undertecknad av invändaren eller dennes ombud.

Invändningen och andra handlingar som åberopas ska ges in i två exemplar.

Ärendenummer:

2024-0117

Registreringsnummer:

85558



1 - 1

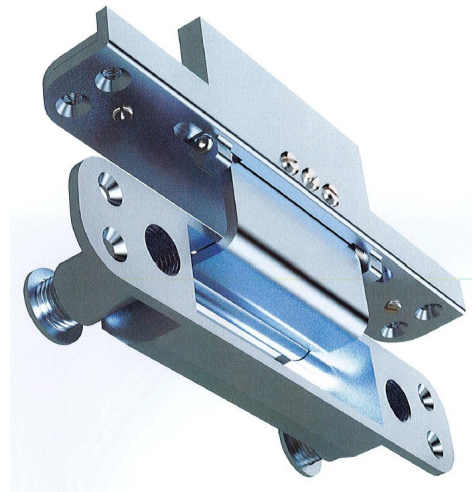

1 - 2

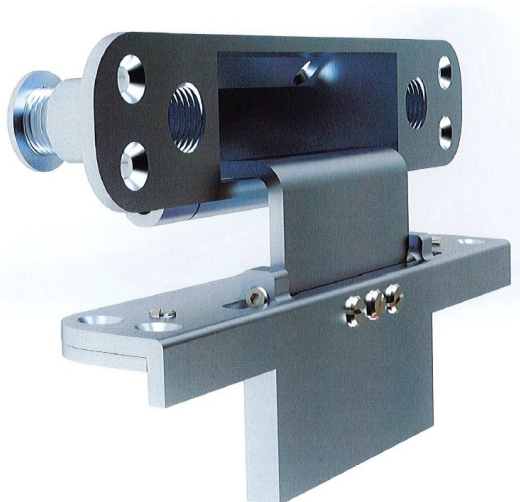

1 - 3

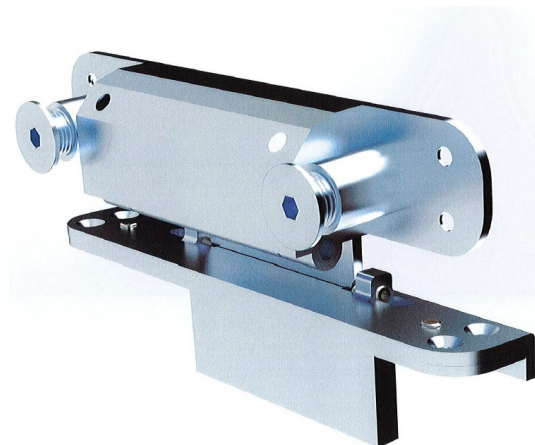

1 - 4

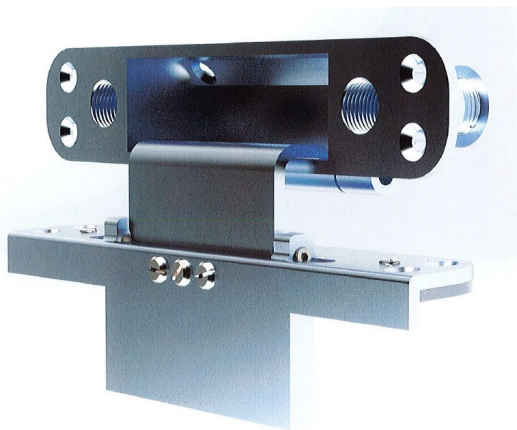

1 - 5

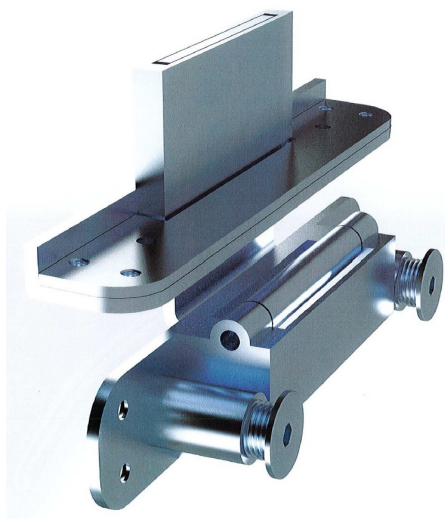

1 - 6

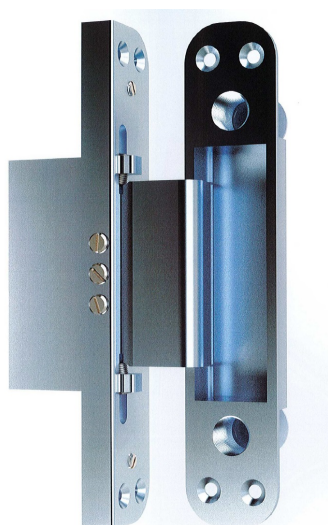

1 - 7

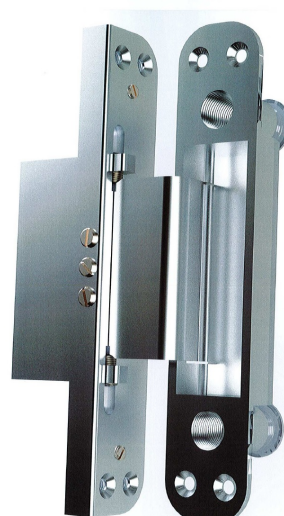

1 - 8

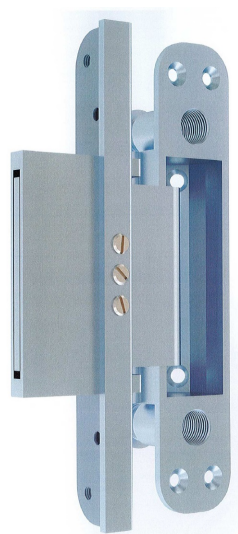

1 - 9

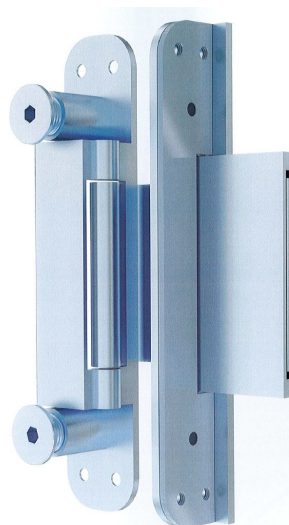

1 - 10

Produkt Nr 1:

Gångjärn

Klasser (LOC 14):

08-06

Formgivare:

Hildemar Svensson

Skräddarebo 3 , 331 74 Bor, Sverige. (1)

Innehavare: Svenska Bo-Produkter AB
Skräddarebo 3 , 331 74 Bor, Sverige.

Ingivningsdag: 2024-07-10

Allmänt tillgänglig: 2025-01-11

Registrerad/kungjord: 2025-01-13

Giltig t.o.m.: 2029-07-10

Ärendenummer:
Registreringsnummer:

2024-0201
85559

THE BUSINESS EVENT CANVAS		The Business Event Canvas by Cathy Rice Chen		Invested events
SPACE What requirements will you need to look for? SPACE	ACTIVITIES What are the activities you could use to reach the short-term goals of this event? DESIGN	SHORT-TERM GOALS What outcomes do you want to achieve by holding this event? DESIGN	PURPOSE Write down the big reason that you want to achieve with your business. DESIGN	TARGET GROUP Which stakeholders should you include in your event to achieve your short-term goals? TARGET GROUP
COMMUNICATION STRATEGY PRE-EVENT: What channels will you use? How much notice will you give? What messaging elements are used? What are you do to optimize your reach? DURING EVENT: How will you welcome guests? How can people find out more? Will you have your contact details? POST-EVENT: How will you follow up with guests? How will you engage people who didn't come? COMMUNICATION	ASSETS What elements of the event or site will be used to give you an edge and what assets you own & for? ASSETS	STAKEHOLDERS Who benefits from your business purpose? TARGET GROUP	ASSUMPTIONS What do you think you know about the stakeholders you've included on your target group? TARGET GROUP	
CALL-TO-ACTION What actions will you ask people to take and when? ENGAGEMENT	VALUE ADD How would your target group benefit from attending your event? Consider your assumptions against your activities. TARGET GROUP			

1 - 1

Produkt Nr 1: Utbildningsmaterial för event
Klasser (LOC 14): 19-07, 19-08
Formgivare: Cathy Chen
Torsborg 408, 19391 Sigtuna, Sverige. (1)

Innehavare: Cathy Chen
Torsborg 408, 19391 Sigtuna, Sverige.

Ingivningsdag: 2024-11-05

Registrerad/kungjord: 2025-01-13

Giltig t.o.m.: 2029-11-05

Ärendenummer:**2024-0195****Registreringsnummer:****85560**

1 - 1



1 - 2



1 - 3

Produkt Nr 1: Handverktyg/virknål för I-snoddar
Klasser (LOC 14): 02-07
Formgivare: Christoffer Hag
Åsgatan 66A, 791 72 Falun, Sverige. (1)
Antonio Källgren
Nedernora 24, 783 93 Stora Skedvi, Sverige. (1)
Kim Efraimsson
Mets Eriks Väg 31, 784 56 Borlänge, Sverige. (1)
Joel Olsson
Trotzgatan 47, 791 72 Falun, Sverige. (1)

Innehavare: House Village AB
Åsgatan 66 A, 791 72 Falun, Sverige.

Ingivningsdag: 2024-10-27
Registrerad/kungjord: 2025-01-13
Giltig t.o.m.: 2029-10-27

Ärendenummer: 2023-0035
Registreringsnummer: 85561

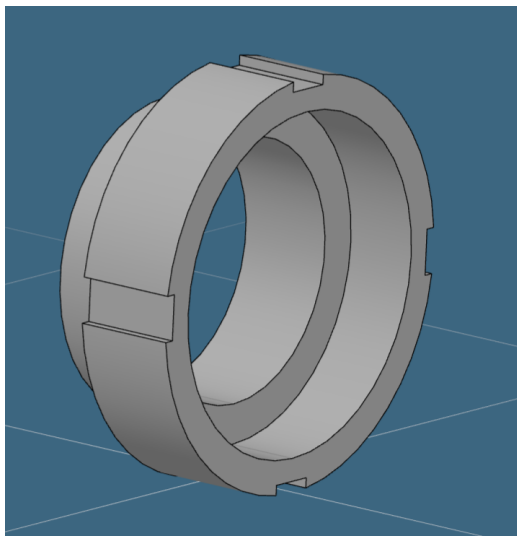

1 - 1

Produkt Nr 1: Adapterring till kikarsikten
Klasser (LOC 14): 16-06
Formgivare: Mattias Arnesson
Fågelviks-Mosserud 429 , 655 94 Karlstad, Sverige. (1)

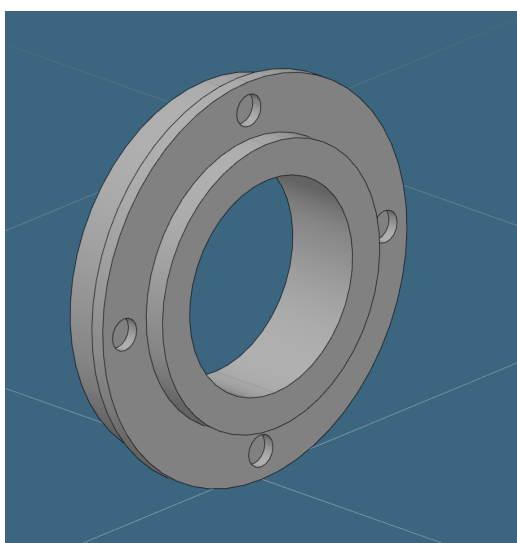

2 - 1

Produkt Nr 2: Adapterring till kikarsikten
Klasser (LOC 14): 16-06
Formgivare: Mattias Arnesson
Fågelviks-Mosserud 429 , 655 94 Karlstad, Sverige. (2)

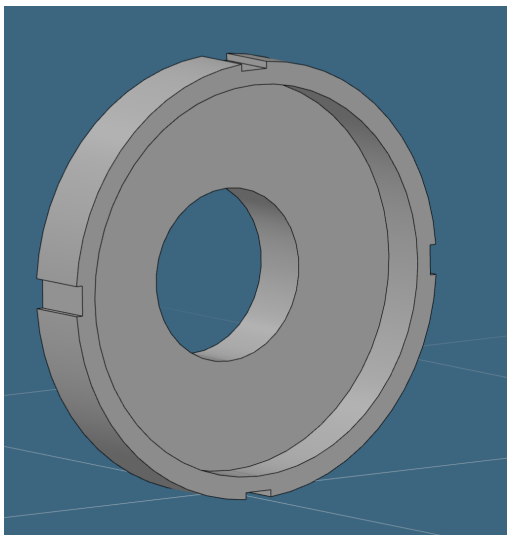

3 - 1

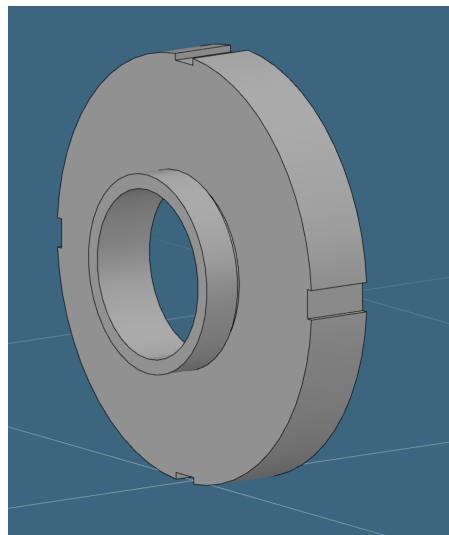

3 - 2

Produkt Nr 3: Adapterring till kikarsikten
Klasser (LOC 14): 16-06
Formgivare: Mattias Arnesson
Fågelviks-Mosserud 429 , 655 94 Karlstad, Sverige. (3)

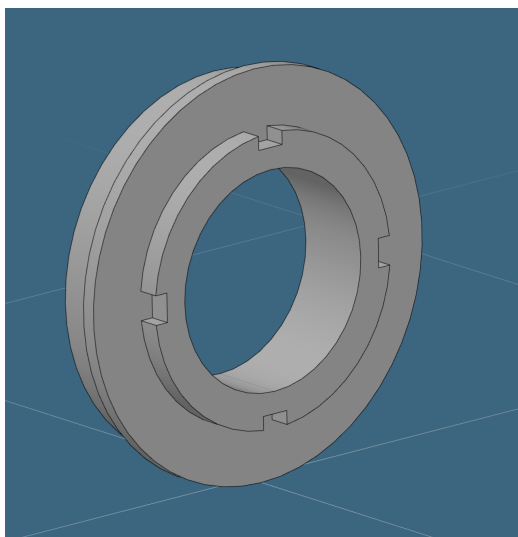

4 - 1

Produkt Nr 4: Adapterring till kikarsikten
Klasser (LOC 14): 16-06
Formgivare: Mattias Arnesson
Fågelviks-Mosserud 429 , 655 94 Karlstad, Sverige. (4)

Innehavare: Mattias Arnesson
Fågelviks-Mosserud 429 , 655 94 Karlstad, Sverige.

Ingivningsdag: 2023-02-05

Registrerad/kungjord: 2025-01-15

Giltig t.o.m.: 2028-02-05

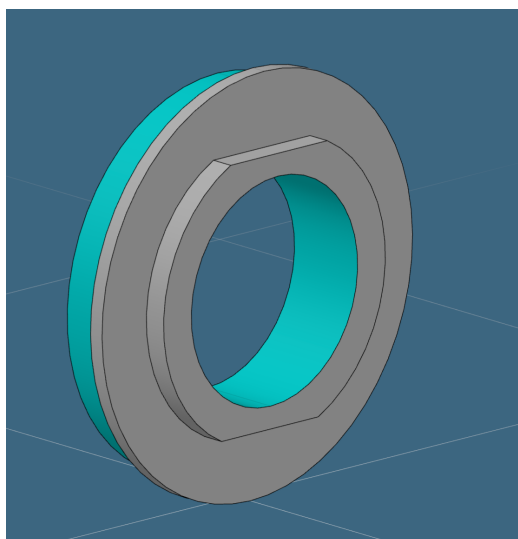
Ärendenummer:**2023-0036****Registreringsnummer:****85562**

1 - 1

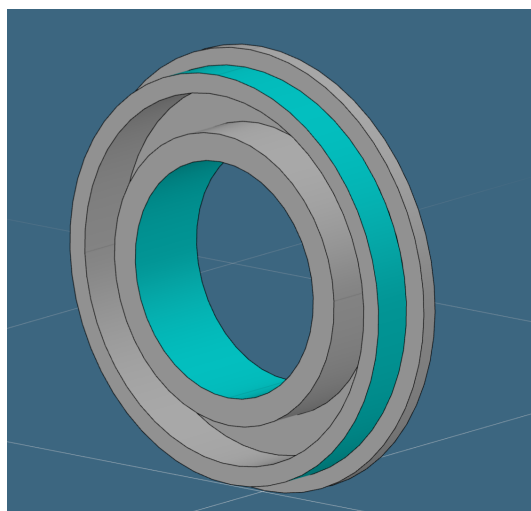

1 - 2

Produkt Nr 1: Adapterplatta till kikarsikten
Klasser (LOC 14): 16-06
Formgivare: Mattias Arnesson
Fågelviks-Mosserud, 65594 Karlstad, Sverige. (1)

Innehavare: Mattias Arnesson
Fågelviks-Mosserud, 65594 Karlstad, Sverige.

Ingivningsdag: 2023-02-10
Registrerad/kungjord: 2025-01-15
Giltig t.o.m.: 2028-02-10

Ärendenummer: 2023-0031
Registreringsnummer: 85563



1 - 1

Produkt Nr 1: Adapterring till kikarsikten
Klasser (LOC 14): 16-06
Formgivare: Mattias Arnesson
Fågelviks-Mosserud, 65594 Karlstad, Sverige. (1)

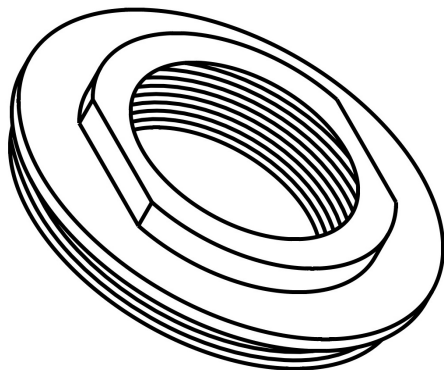

2 - 1

Produkt Nr 2: Adapterring till kikarsikten
Klasser (LOC 14): 16-06
Formgivare: Mattias Arnesson
Fågelviks-Mosserud, 65594 Karlstad, Sverige. (2)

Innehavare: Mattias Arnesson
Fågelviks-Mosserud, 65594 Karlstad, Sverige.

Ingivningsdag: 2023-02-03
Registrerad/kungjord: 2025-01-15
Giltig t.o.m.: 2028-02-03

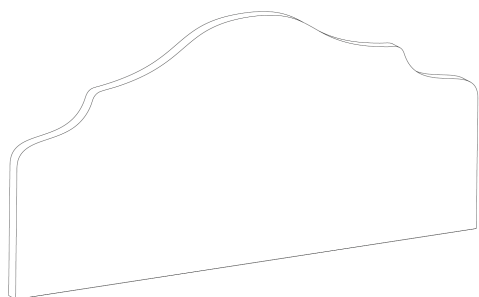
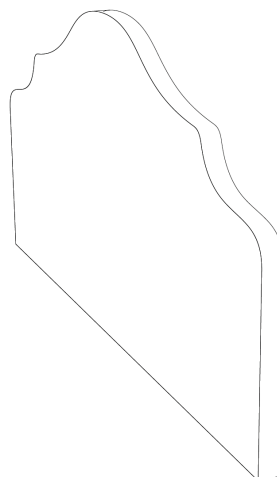
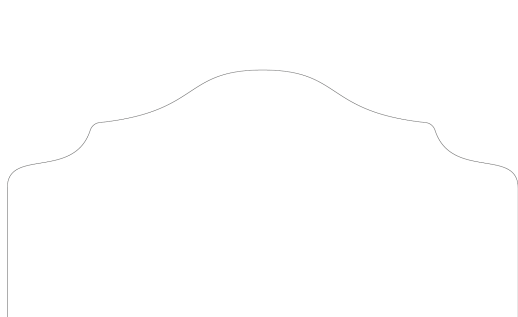
Ärendenummer:**2024-0227****Registreringsnummer:****85564****1 - 1****1 - 2****1 - 3****Produkt Nr 1:****Sänggavel****Klasser (LOC 14):****06-06****Formgivare:****Mikaela Rosén Östlund****Läroverksvägen 5, 18142 Lidingö, Sverige. (1)**

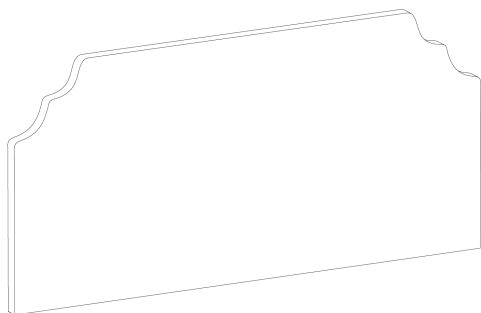

2 - 1

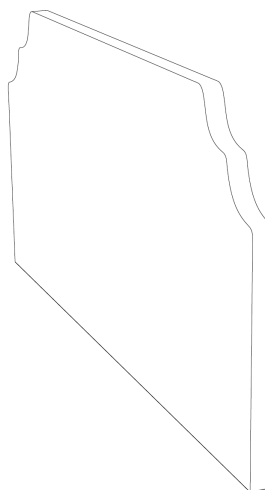

2 - 2

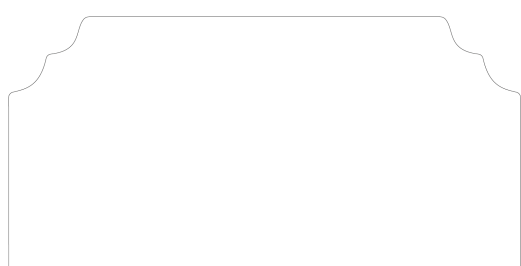

2 - 3

Produkt Nr 2: Sänggavel
Klasser (LOC 14): 06-06
Formgivare: Mikaela Rosén Östlund
Läroverksvägen 5, 18142 Lidingö, Sverige. (2)

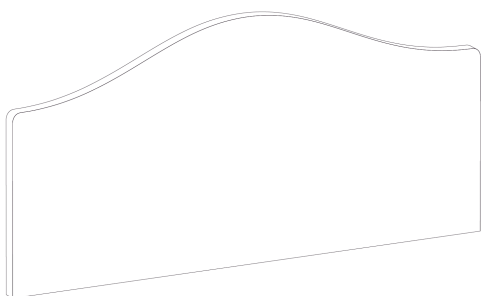

3 - 1

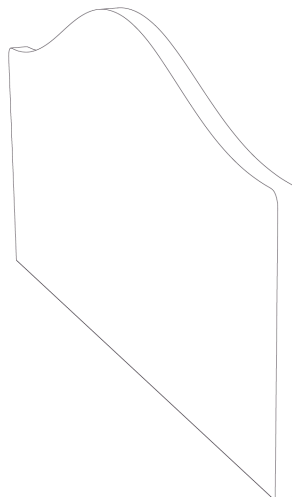

3 - 2

**3 - 3**

Produkt Nr 3: Sänggavel
Klasser (LOC 14): 06-06
Formgivare: Mikaela Rosén Östlund
Läroverksvägen 5, 18142 Lidingö, Sverige. (3)
Innehavare: Ylse Design AB
Södra hamnvägen 13, 115 41 STOCKHOLM, Sverige.
Ingivningsdag: 2024-12-11
Registrerad/kungjord: 2025-01-16
Giltig t.o.m.: 2029-12-11

Ärendenummer: 2024-0206
Registreringsnummer: 85565

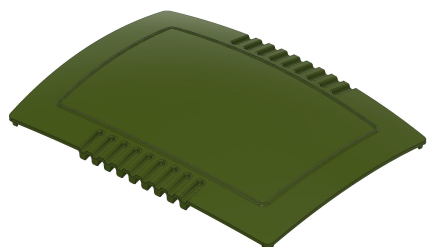

1 - 1



1 - 2



1 - 3

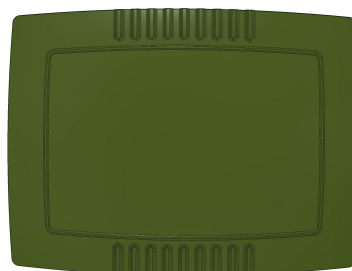

1 - 4

Produkt Nr 1: Överdel till luftpump
Klasser (LOC 14): 15-02
Formgivare: Viktor Eriksson
Torsgatan 2 (box 2337) , 111 75 Stockholm, Sverige. (1)

Innehavare: SUNBEAMsystem AB
Torsgatan 2 , 111 75 Stockholm, Sverige.

Ingivningsdag: 2024-11-08

Registrerad/kungjord: 2025-01-21

Giltig t.o.m.: 2029-11-08

Ärendenummer: 2024-0123
Registreringsnummer: 85566

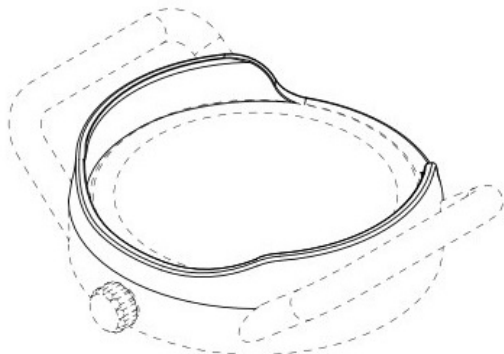

1 - 1

Produkt Nr 1: Bakre boett för klocka
Klasser (LOC 14): 10-07
Formgivare: Yasemin Fallai
Sibyllegatan 79 , 114 43 Stockholm, Sverige. (1)

Innehavare: Cooci Sweden AB
Sibyllegatan 79 , 114 43 Stockholm, Sverige.

Ingivningsdag: 2024-07-20
Allmänt tillgänglig: 2025-01-21
Registrerad/kungjord: 2025-01-22
Giltig t.o.m.: 2029-07-20

Ärendenummer:

2024-0209

Registreringsnummer:

85567

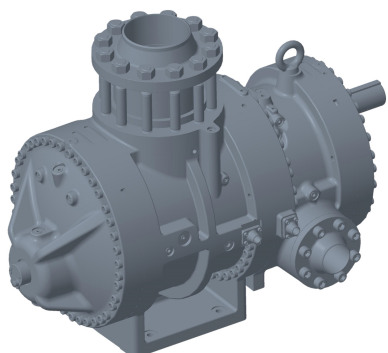

1 - 1

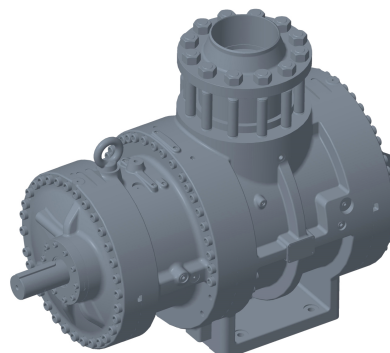

1 - 2

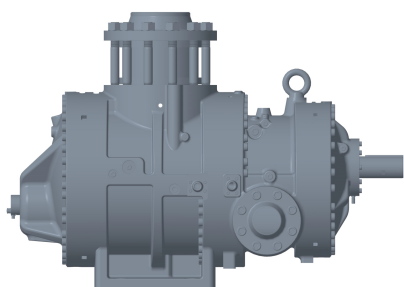

1 - 3

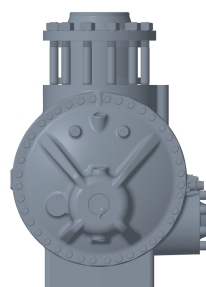

1 - 4

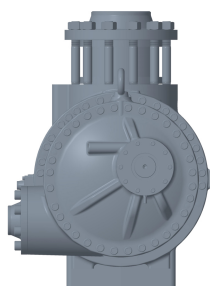

1 - 5

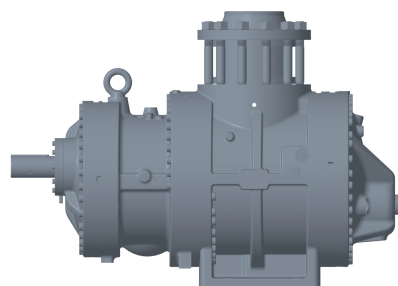

1 - 6

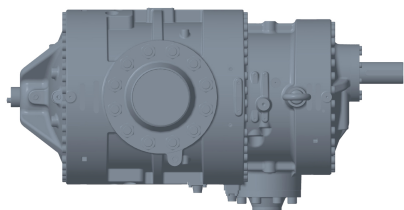

1 - 7

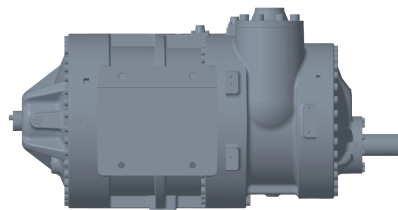

1 - 8

Produkt Nr 1: Skruvkompressor
Klasser (LOC 14): 15-02
Formgivare: Yunzhen LIN
Dongjiang West Road No.8, Liren Industrial Area, Hangcheng Street, Changle District, Fuzhou City,, 0 Fujian Province,, Kina. (1)
Deqiang WEI
Dongjiang West Road No.8, Liren Industrial Area, Hangcheng Street, Changle District, Fuzhou City,, 0 Fujian Province,, Kina. (1)
Tuo HUANG
Dongjiang West Road No.8, Liren Industrial Area, Hangcheng Street, Changle District, Fuzhou City,, 0 Fujian Province,, Kina. (1)
Zongjie XIE
Dongjiang West Road No.8, Liren Industrial Area, Hangcheng Street, Changle District, Fuzhou City,, 0 Fujian Province,, Kina. (1)
Tao JIANG
Dongjiang West Road No.8, Liren Industrial Area, Hangcheng Street, Changle District, Fuzhou City,, 0 Fujian Province, Kina. (1)

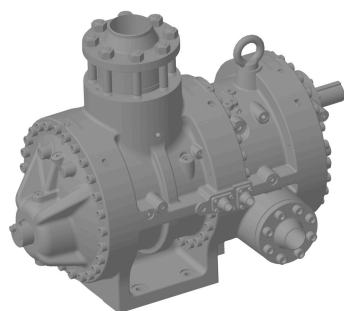

2 - 1

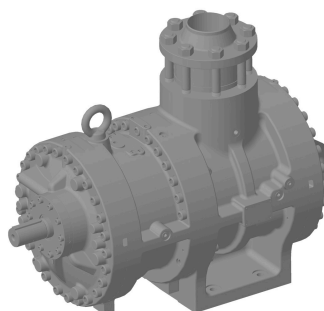

2 - 2

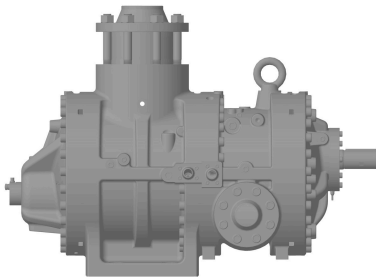

2 - 3

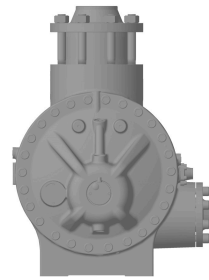

2 - 4

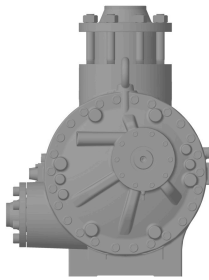

2 - 5

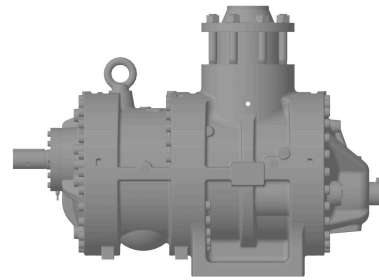

2 - 6

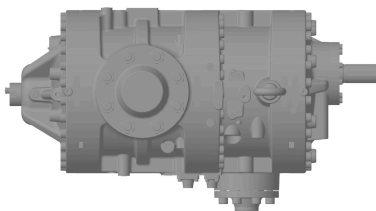

2 - 7

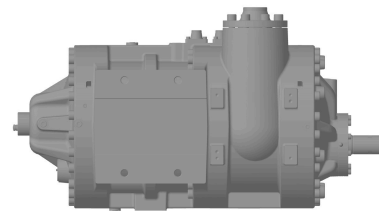

2 - 8

Produkt Nr 2: Skruvkompressor
Klasser (LOC 14): 15-02
Formgivare: Yunzhen LIN
Dongjiang West Road No.8, Liren Industrial Area, Hangcheng
Street, Changle District, Fuzhou City,, 0 Fujian Province,, Kina. (2)

Deqiang WEI
Dongjiang West Road No.8, Liren Industrial Area, Hangcheng
Street, Changle District, Fuzhou City,, 0 Fujian Province,, Kina. (2)

Tuo HUANG
Dongjiang West Road No.8, Liren Industrial Area, Hangcheng
Street, Changle District, Fuzhou City,, 0 Fujian Province,, Kina. (2)

Zongjie XIE
Dongjiang West Road No.8, Liren Industrial Area, Hangcheng
Street, Changle District, Fuzhou City,, 0 Fujian Province,, Kina. (2)

Tao JIANG
Dongjiang West Road No.8, Liren Industrial Area, Hangcheng
Street, Changle District, Fuzhou City,, 0 Fujian Province, Kina. (2)

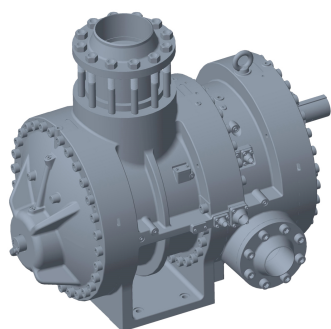

3 - 1

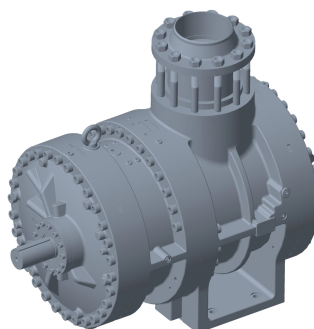

3 - 2

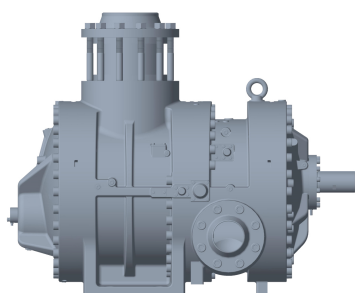

3 - 3

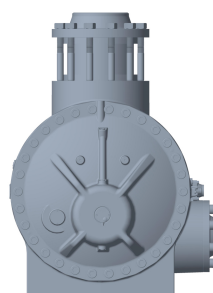

3 - 4

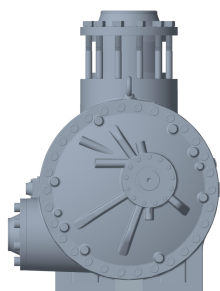

3 - 5

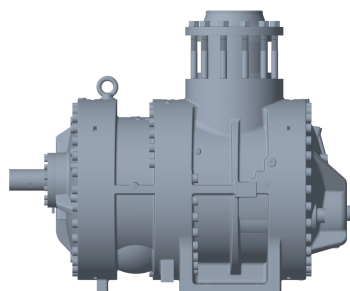

3 - 6

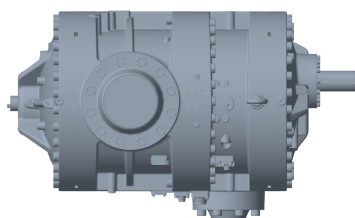

3 - 7

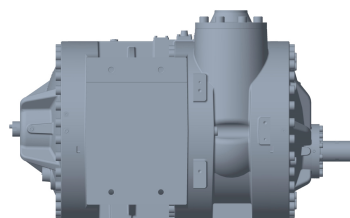

3 - 8

Produkt Nr 3: Skruvkompressor
Klasser (LOC 14): 15-02
Formgivare: Yunzhen LIN
Dongjiang West Road No.8, Liren Industrial Area, Hangcheng Street, Changle District, Fuzhou City,, 0 Fujian Province,, Kina. (3)
Deqiang WEI
Dongjiang West Road No.8, Liren Industrial Area, Hangcheng Street, Changle District, Fuzhou City,, 0 Fujian Province,, Kina. (3)
Tuo HUANG
Dongjiang West Road No.8, Liren Industrial Area, Hangcheng Street, Changle District, Fuzhou City,, 0 Fujian Province,, Kina. (3)
Zongjie XIE
Dongjiang West Road No.8, Liren Industrial Area, Hangcheng Street, Changle District, Fuzhou City,, 0 Fujian Province,, Kina. (3)
Tao JIANG
Dongjiang West Road No.8, Liren Industrial Area, Hangcheng Street, Changle District, Fuzhou City,, 0 Fujian Province, Kina. (3)

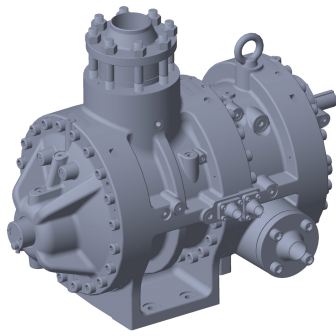

4 - 1

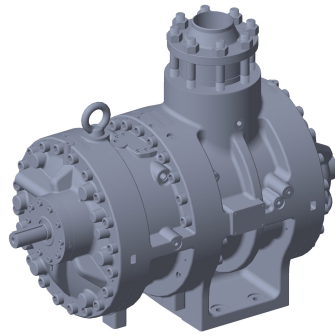

4 - 2

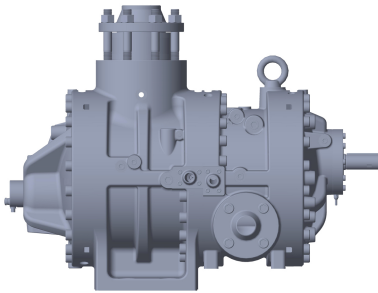

4 - 3

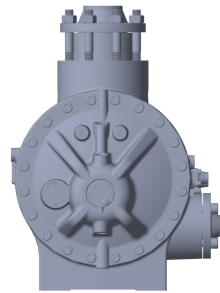

4 - 4

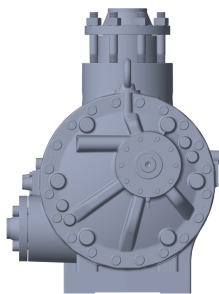

4 - 5

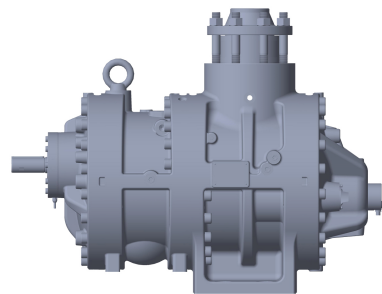

4 - 6

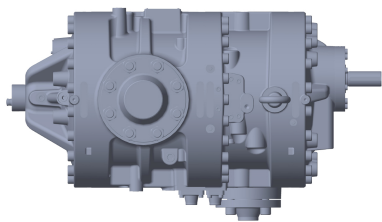

4 - 7

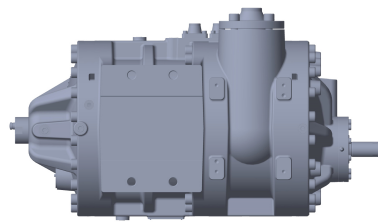

4 - 8

Produkt Nr 4: Skruvkompressor
Klasser (LOC 14): 15-02
Formgivare: Yunzhen LIN
Dongjiang West Road No.8, Liren Industrial Area, Hangcheng Street, Changle District, Fuzhou City,, 0 Fujian Province,, Kina. (4)
Deqiang WEI
Dongjiang West Road No.8, Liren Industrial Area, Hangcheng Street, Changle District, Fuzhou City,, 0 Fujian Province,, Kina. (4)
Tuo HUANG
Dongjiang West Road No.8, Liren Industrial Area, Hangcheng Street, Changle District, Fuzhou City,, 0 Fujian Province,, Kina. (4)
Zongjie XIE
Dongjiang West Road No.8, Liren Industrial Area, Hangcheng Street, Changle District, Fuzhou City,, 0 Fujian Province,, Kina. (4)
Tao JIANG
Dongjiang West Road No.8, Liren Industrial Area, Hangcheng Street, Changle District, Fuzhou City,, 0 Fujian Province, Kina. (4)

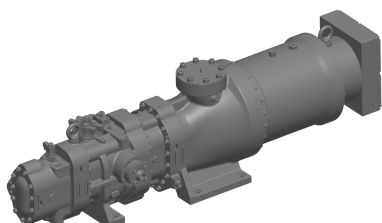

5 - 1

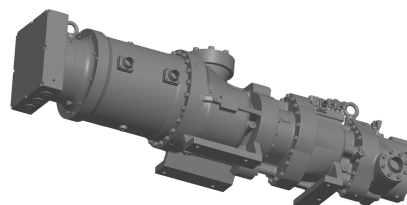

5 - 2

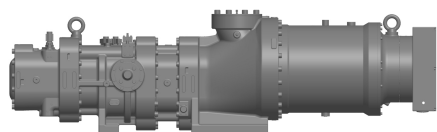

5 - 3

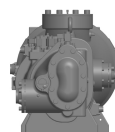

5 - 4

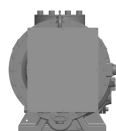

5 - 5

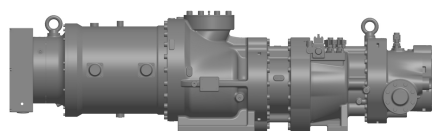

5 - 6

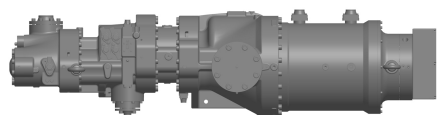

5 - 7

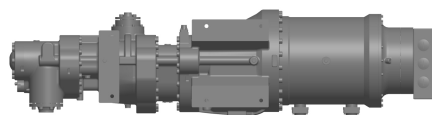

5 - 8

Produkt Nr 5: Skruvkompressor
Klasser (LOC 14): 15-02
Formgivare: Yunzhen LIN
Dongjiang West Road No.8, Liren Industrial Area, Hangcheng
Street, Changle District, Fuzhou City,, 0 Fujian Province,, Kina. (5)

Street, Changle District, Fuzhou City,, 0 Fujian Province,, Kina. (5)

Deqiang WEI

Dongjiang West Road No.8, Liren Industrial Area, Hangcheng

Street, Changle District, Fuzhou City,, 0 Fujian Province,, Kina. (5)

Tuo HUANG

Dongjiang West Road No.8, Liren Industrial Area, Hangcheng

Street, Changle District, Fuzhou City,, 0 Fujian Province,, Kina. (5)

Zongjie XIE

Dongjiang West Road No.8, Liren Industrial Area, Hangcheng

Street, Changle District, Fuzhou City,, 0 Fujian Province,, Kina. (5)

Tao JIANG

Dongjiang West Road No.8, Liren Industrial Area, Hangcheng

Street, Changle District, Fuzhou City,, 0 Fujian Province, Kina. (5)

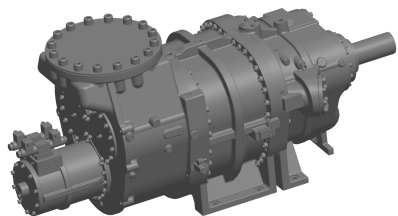

6 - 1

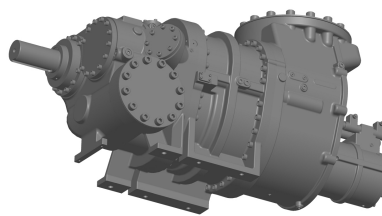

6 - 2

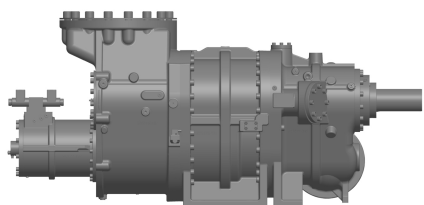

6 - 3

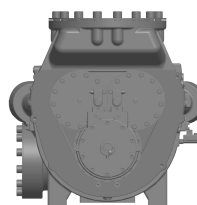

6 - 4

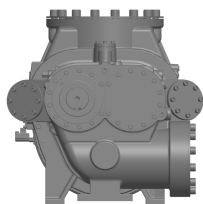

6 - 5

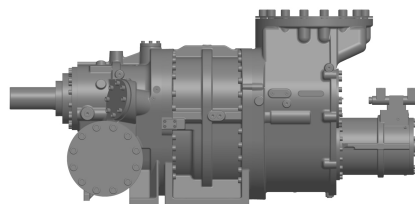

6 - 6

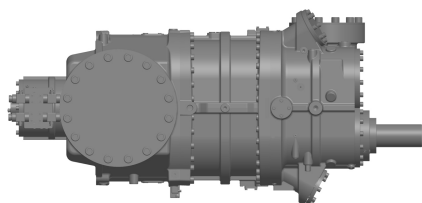

6 - 7

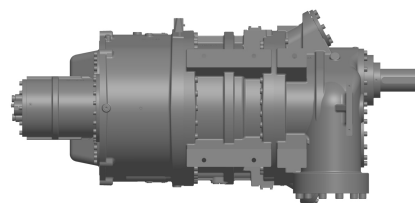

6 - 8

Produkt Nr 6: Skruvkompressor
Klasser (LOC 14): 15-02
Formgivare: Yunzhen LIN
Dongjiang West Road No.8, Liren Industrial Area, Hangcheng Street, Changle District, Fuzhou City,, 0 Fujian Province,, Kina. (6)
Deqiang WEI
Dongjiang West Road No.8, Liren Industrial Area, Hangcheng Street, Changle District, Fuzhou City,, 0 Fujian Province,, Kina. (6)
Tuo HUANG
Dongjiang West Road No.8, Liren Industrial Area, Hangcheng Street, Changle District, Fuzhou City,, 0 Fujian Province,, Kina. (6)
Zongjie XIE
Dongjiang West Road No.8, Liren Industrial Area, Hangcheng Street, Changle District, Fuzhou City,, 0 Fujian Province,, Kina. (6)
Tao JIANG
Dongjiang West Road No.8, Liren Industrial Area, Hangcheng Street, Changle District, Fuzhou City,, 0 Fujian Province, Kina. (6)

Innehavare: Fujian Snowman Compressor Co., Ltd
Dongjiang West Road No.8, Liren Industrial Area, Hangcheng Street, Changle District, Fuzhou City,, 0 Fujian Province, Kina.

Ombud: Swea IP Law AB
Kopparbergsvägen 6, 722 13 Västerås, Sverige.

Ingivningsdag: 2024-11-15

Registrerad/kungjord: 2025-01-24

Giltig t.o.m.: 2029-11-15

06 - Förnyelser

<u>Reg nr</u>	<u>Beslutsdatum</u>	<u>Förnyad till och med</u>
84683	2025-01-12	2030-01-19
84672	2025-01-14	2030-03-09
84573	2025-01-14	2029-10-30
81059	2025-01-14	2030-01-21
81061	2025-01-15	2030-02-08
81145	2025-01-15	2030-02-09
84722	2025-01-18	2030-05-11
84725	2025-01-21	2030-06-11
84670	2025-01-22	2030-01-21
84743	2025-01-22	2030-07-02
83182	2025-01-23	2030-01-29

07 - Ändringar i designregistret

Registrering nr: 84573
Registrerad: 2020-01-07
Ändring: Begränsning av design

Anteckning:
Mönster nummer 2 och 3 har utgått ur mönsterregistreringen.

Innehavare: Ragne Edebol
Oxelgatan 13, 694 72 Östansjö, Sverige.

Registrering nr: 85234
Registrerad: 2023-06-08
Ändring: Vanlig överlåtelse

Innehavare: Eva Malm
ROSLINS VÄG 2 LGH 1301, 21755 MALMÖ, Sverige.

Registrering nr: 69234
Registrerad: 2003-01-22
Ändring: Vanlig överlåtelse

Innehavare: SKAKO Concrete A/S
Bygmestervej 2 , 5600 Faaborg, Danmark.
Ombud: Zacco Denmark A/S
Arne Jacobsens Allé 15 , 2300 Copenhagen , Danmark.

09 - Avförda registreringar

66058 66062 66164 66165 80901 82839 84484 84504
